

THREE-HINGED INLET/OUTLET BARRIER
FOR RCB

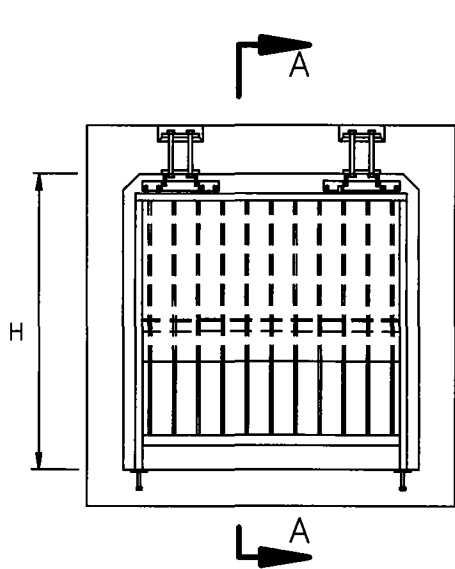

TWO-HINGED
INLET/OUTLET BARRIER
FOR RCB

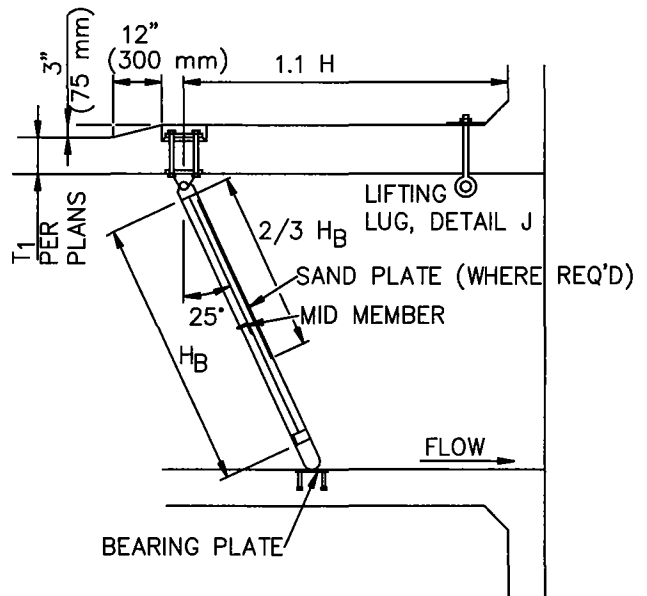

SECTION A-A

STANDARD PLANS FOR PUBLIC WORKS CONSTRUCTION

PROMULGATED BY THE
PUBLIC WORKS STANDARDS INC.
GREENBOOK COMMITTEE
1993
REV. 2005, 2008

SLOPED PROTECTION BARRIER

USE WITH STANDARD SPECIFICATIONS FOR PUBLIC WORKS CONSTRUCTION

STANDARD PLAN

360-2

SHEET 1 OF 8