

EAST JORDAN
IRON WORKS, INC.
P.O. BOX 439
EAST JORDAN, MI. 49727
1-800-874-4100
FAX 231-536-4458

DRAWN JIJ	DATE 12/03/03
APPROVED	DATE

**MANHOLE
COVER**
LBIW X106

PRODUCT NO.
00310623

CATALOG NO.
3106C

REF. PRODUCT DRAWING
310620

EST. WT.
COVER: 300 LBS 136kg

OPEN AREA
N/A

MAT'L SPEC.
COVER - GRAY IRON
ASTM A48 CL35B

LOAD RATING
HEAVY DUTY

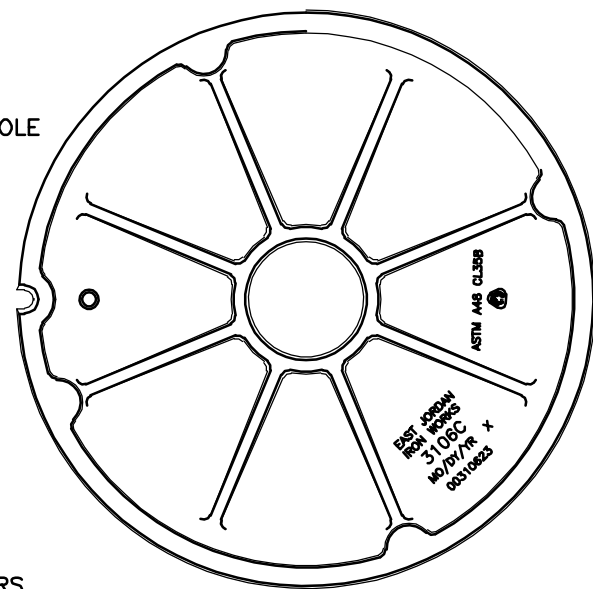
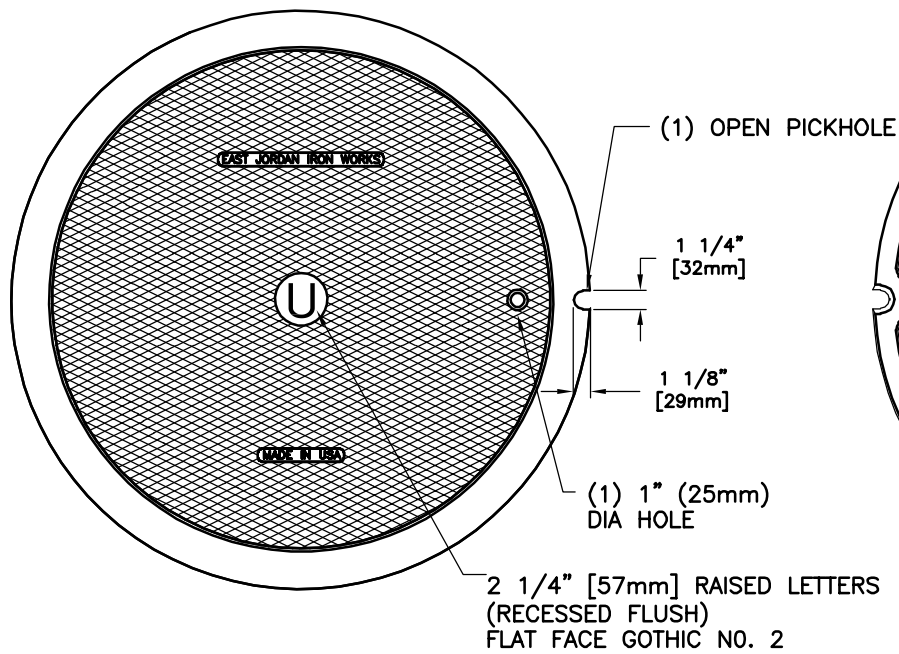

COVER BACK

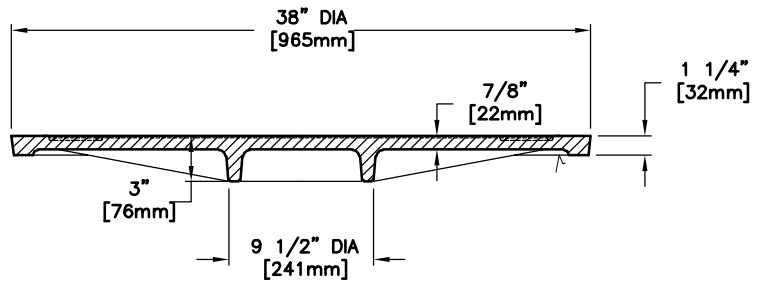

SECTION

√ MACHINED SURFACE