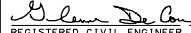

DIST	COUNTY	ROUTE	POST MILES TOTAL PROJECT	SHEET TOTAL NO. SHEETS

  
 REGISTERED CIVIL ENGINEER

May 1, 2006  
 PLANS APPROVAL DATE

No. C34547  
 Exp. 9-30-07  
 CIVIL  
 STATE OF CALIFORNIA

*The State of California or its officers or agents shall not be responsible for the accuracy or completeness of electronic copies of this plan sheet.*

To get to the Caltrans web site, go to <http://www.dot.ca.gov>

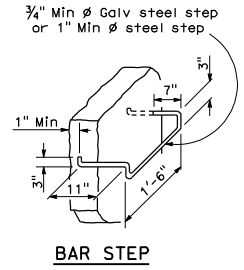
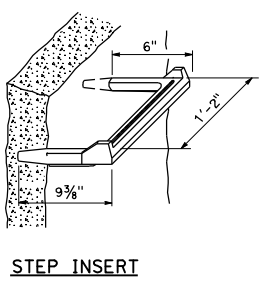
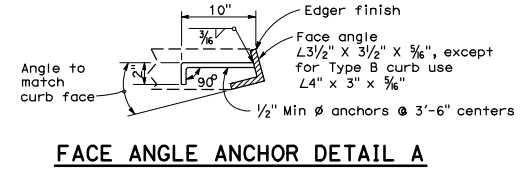
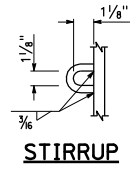
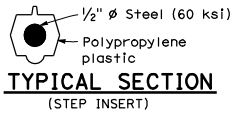

**FACE ANCHOR DETAIL A**

Length of Curb Opening	No of Anchors
3'-6" or Less	2
7'-0"	3
10'-0"	4
14'-0"	5
21'-0"	7

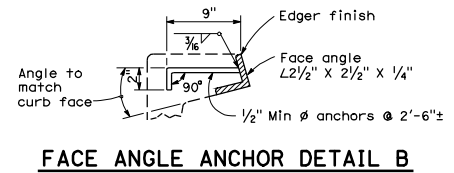
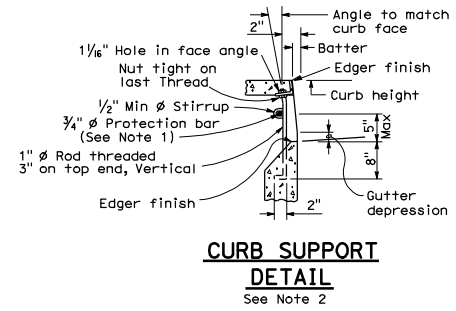

**STEP DETAILS**

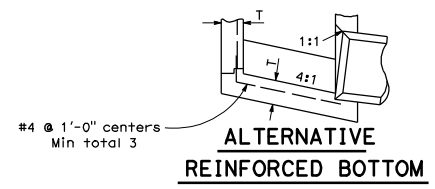
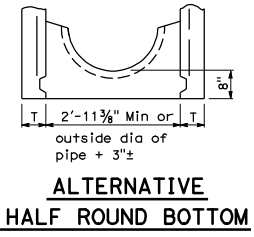

**NOTES:**

- When shown on the project plans, place a  $\frac{3}{4}$ "  $\phi$  plain round protection bar horizontally across length of the opening and bend back 4" into the inlet wall on each side.
- Curb supports shall be evenly spaced and minimal in number such that maximum span of unsupported curb is 7'-0".

STATE OF CALIFORNIA  
 DEPARTMENT OF TRANSPORTATION  
**DRAINAGE INLET DETAILS**  
 NO SCALE

**D74C**

2006 STANDARD PLAN D74C