

EAST JORDAN  
IRON WORKS, INC.  
P.O. BOX 439  
EAST JORDAN, MI. 49727  
1-800-874-4100  
FAX 231-536-4458

DRAWN DEW	DATE 11/10/03
--------------	------------------

APPROVED	DATE
----------	------

MANHOLE COVER  
LBIW X100

PRODUCT NO.

**00310025**

CATALOG NO.

**3100A**

REF. PRODUCT DRAWING

00310020

EST. WT.

COVER: 162 LBS 73kg

OPEN AREA

N/A

MAT'L SPEC.

COVER - GRAY IRON  
ASTM A48 CL35

LOAD RATING

**HEAVY DUTY**

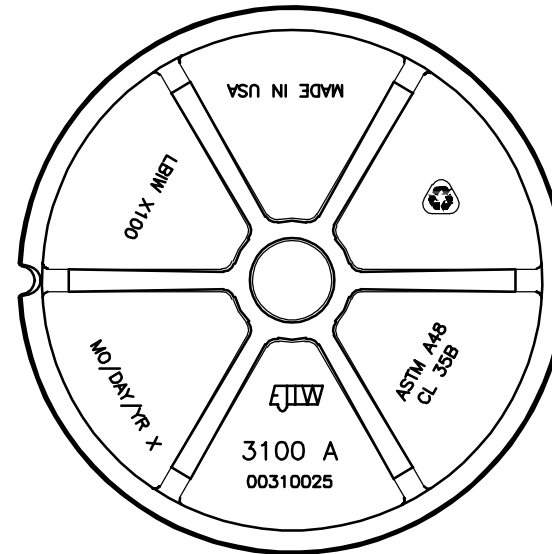
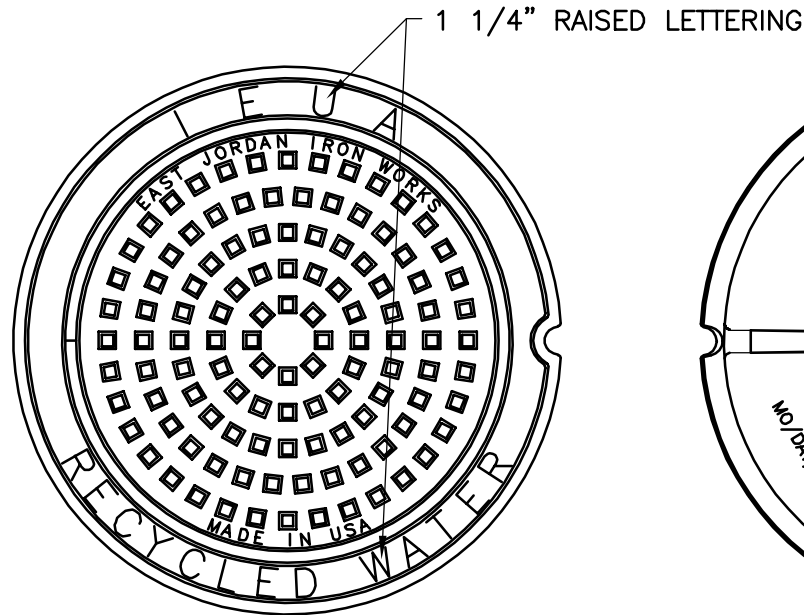

BOTTOM VIEW

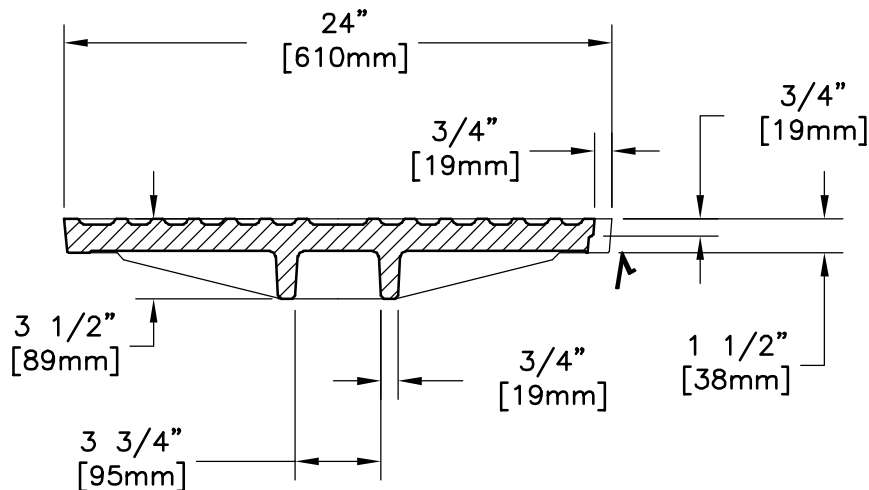

SECTION

√ MACHINED SURFACE