

1 1/2" BOLD GOTHIC
RAISED LETTERING
(RECESSED FLUSH)

2 1/4" BOLD GOTHIC
RAISED LETTERING
(RECESSED FLUSH)

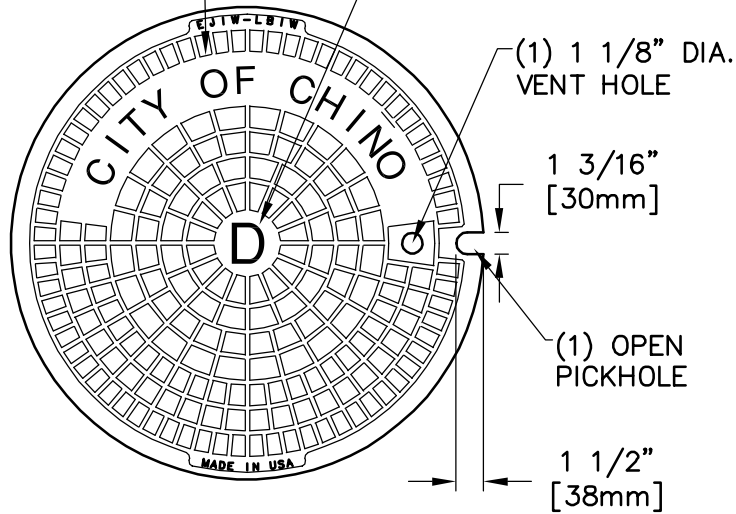

PLAN VIEW

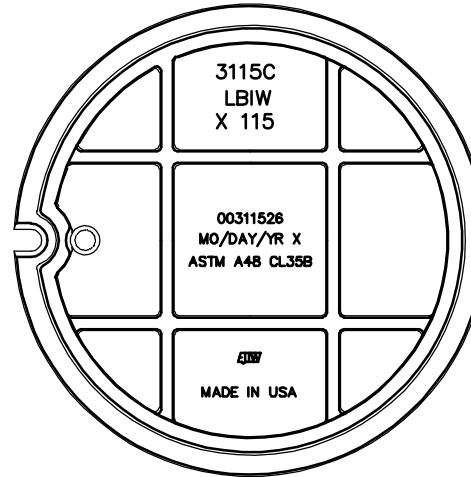

BOTTOM VIEW

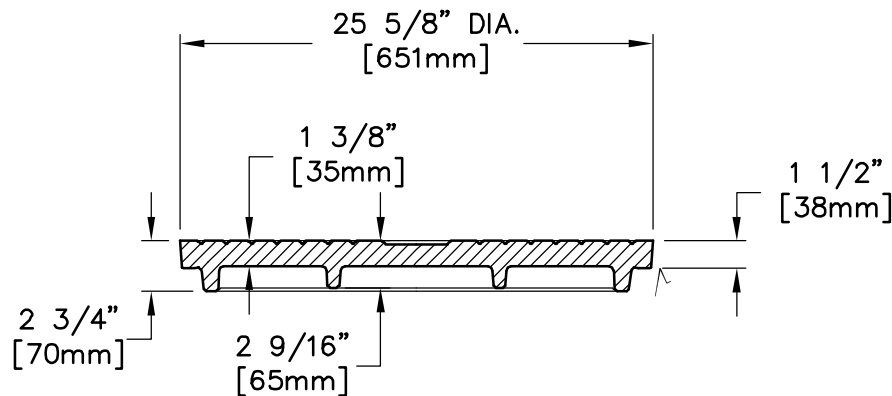

SECTION VIEW

√ MACHINED SURFACE

EAST JORDAN
IRON WORKS, INC.
P.O. BOX 439
EAST JORDAN, MI. 49727
1-800-874-4100
FAX 231-536-4458

DRAWN DEW	DATE 04/22/05
APPROVED	DATE

**MANHOLE
COVER
(LBIW X115)**

PRODUCT NO.
00311526

CATALOG NO.
3115C

REF. PRODUCT DRAWING
311522

EST. WT.
COVER: 210 LBS 95kg

OPEN AREA
N/A

MAT'L SPEC.
FRAME - GRAY IRON
ASTM A48 CL35B

LOAD RATING
HEAVY DUTY