

**EAST JORDAN
IRON WORKS, INC.**
 P.O. BOX 439
 EAST JORDAN, MI. 49727
 1-800-874-4100
 FAX 231-536-4458

DRAWN PFB	DATE 02/27/06
APPROVED	DATE

MANHOLE COVER

PRODUCT NO.
00318024

CATALOG NO.
3180C

REF. PRODUCT DRAWING
00318023

EST. WT.
 COVER: 153 LBS 70kg

OPEN AREA
 N/A

MAT'L SPEC.
 COVER - GRAY IRON
 ASTM A48 CL35B

LOAD RATING
HEAVY DUTY

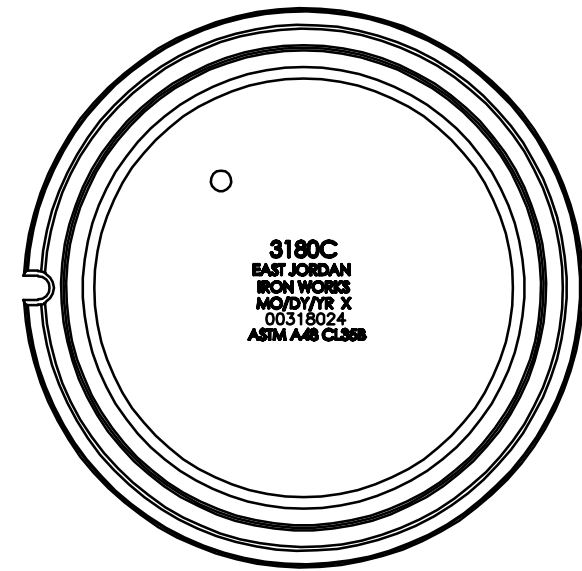
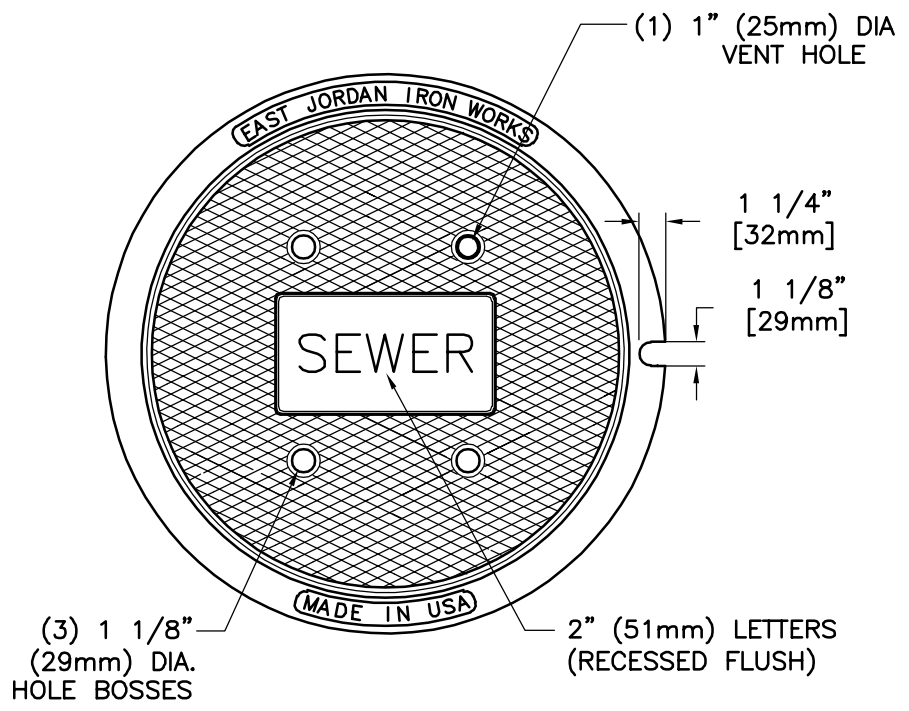

BOTTOM VIEW

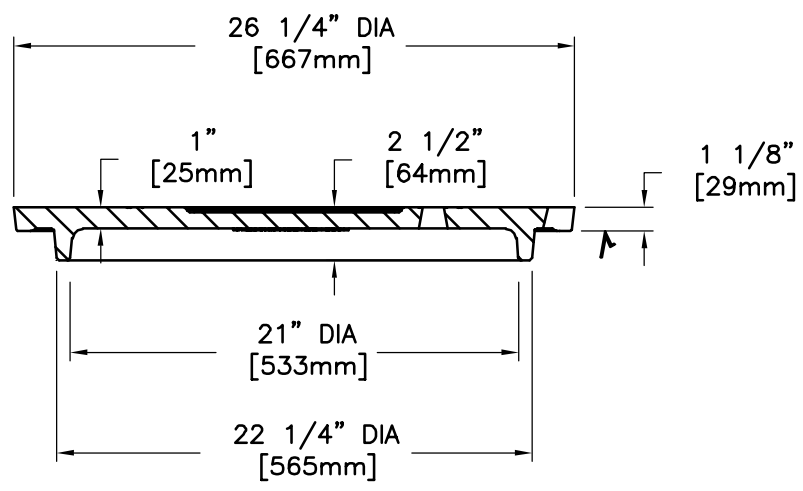

COVER SECTION

√ MACHINED SURFACE