

EAST JORDAN
IRON WORKS, INC.
P.O. BOX 439
EAST JORDAN, MI. 49727
1-800-874-4100
FAX 231-536-4458

DRAWN DEW	DATE 11/10/03
--------------	------------------

APPROVED	DATE
----------	------

MANHOLE COVER
LBIW X100

PRODUCT NO.

00310027

CATALOG NO.

3100A

REF. PRODUCT DRAWING

00310020

EST. WT.

COVER: 162 LBS 73kg

OPEN AREA

N/A

MAT'L SPEC.

COVER - GRAY IRON
ASTM A48 CL35

LOAD RATING

HEAVY DUTY

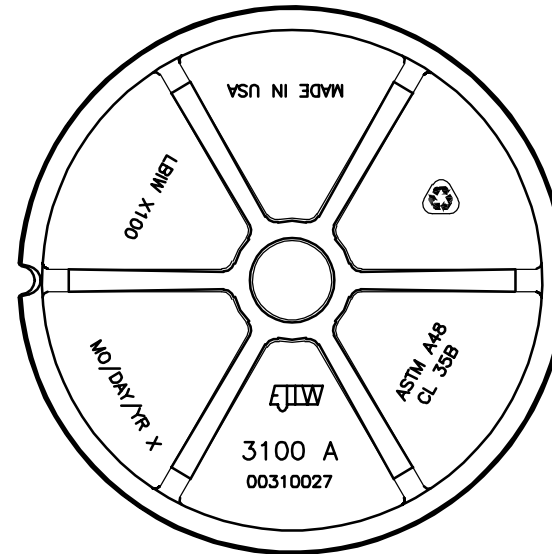
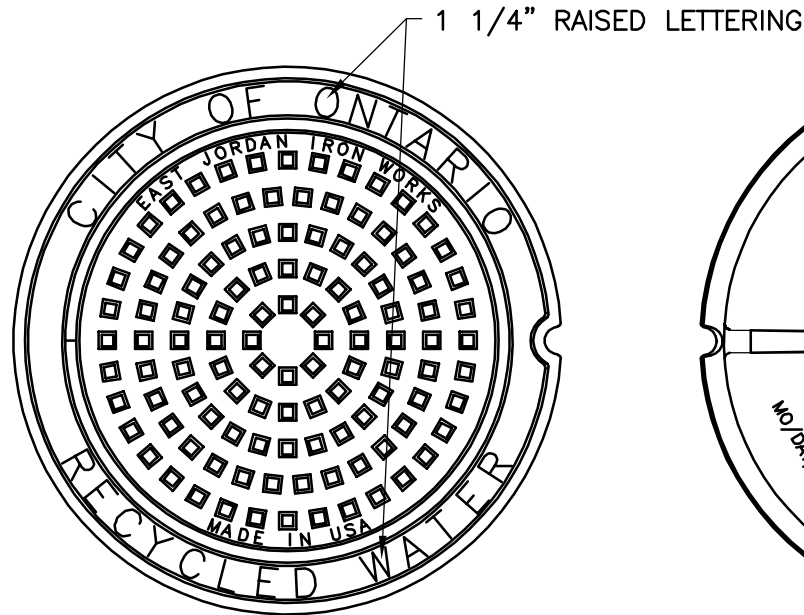

BOTTOM VIEW

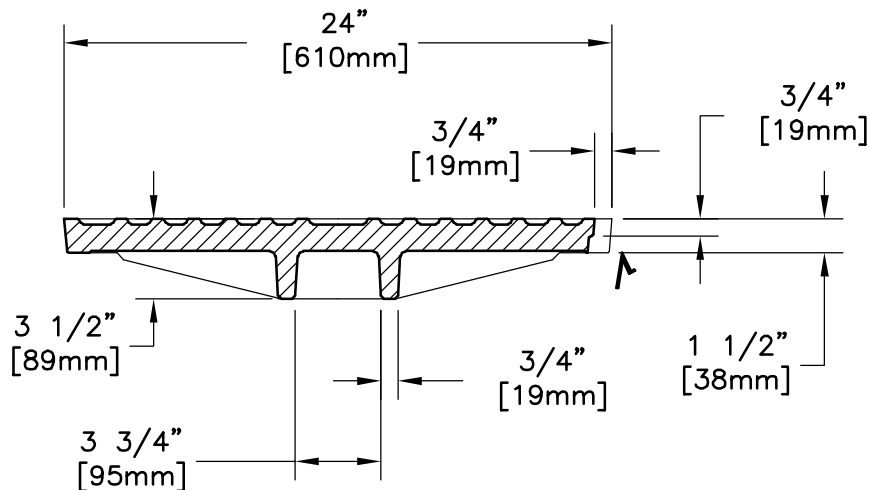

SECTION

√ MACHINED SURFACE